

# BR2SD882DQ

Rev.A Mar.-2022

## 描述 / Descriptions

TO-252 塑封封装 NPN 半导体三极管。Silicon NPN transistor in a TO-252 Plastic Package.

## 特征 / Features

饱和压降  $V_{CE(sat)}$  小,  $h_{FE}$  高且线性极好, 符合 AEC-Q101 标准高可靠性要求, 无卤产品。

Low saturation voltage, excellent  $h_{FE}$  linearity and high  $h_{FE}$ , Qualified to AEC-Q101 Standards for High Reliability, HF Product.

## 用途 / Applications

用于 3 瓦音频放大输出, 电压调节器, 电源转换和继电器驱动, 满足汽车应用的严格要求。

Output stage of 3 watts audio amplifier, voltage regulator, DC-DC converter and relay driver, Meet the stringent requirements of automotive applications.

## 内部等效电路 / Equivalent Circuit

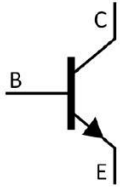

## 引脚排列 / Pinning

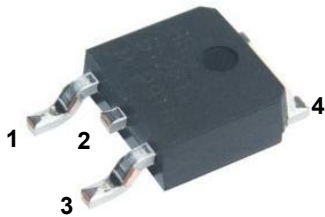

PIN1 : Base

PIN 2,4 : Collector

PIN 3 : Emitter

## 放大及印章代码 / $h_{FE}$ Classifications & Marking

$h_{FE}$ Classifications Symbol	R	Q	P	E
$h_{FE}$ Range	60~120	100~200	160~320	200~400

**极限参数 / Absolute Maximum Ratings(Ta=25°C)**

参数 Parameter	符号 Symbol	数值 Rating	单位 Unit
Collector to Base Voltage	$V_{CBO}$	40	V
Collector to Emitter Voltage	$V_{CEO}$	30	V
Emitter to Base Voltage	$V_{EBO}$	5.0	V
Collector Current - Continuous	$I_C$	3.0	A
Collector Power Dissipation	$P_C$	1.0	W
	$P_{C(Tc=25^\circ C)}$	10	W
Junction Temperature	$T_J$	150	°C
Storage Temperature Range	$T_{stg}$	-55~150	°C

**电性能参数 / Electrical Characteristics(Ta=25°C)**

参数 Parameter	符号 Symbol	测试条件 Test Conditions	最小值 Min	典型值 Typ	最大值 Max	单位 Unit
Collector Cut-Off Current	$I_{CBO}$	$V_{CB}=30V$ $I_E=0$			1.0	$\mu A$
Emitter Cut-Off Current	$I_{EBO}$	$V_{EB}=3.0V$ $I_C=0$			1.0	$\mu A$
DC Current Gain	$h_{FE(1)}$	$V_{CE}=2.0V$ $I_C=1.0A$	60	160	400	
	$h_{FE(2)}$	$V_{CE}=2.0V$ $I_C=20mA$	30	150		
Collector to Emitter Saturation Voltage	$V_{CE(sat)}$	$I_C=2.0A$ $I_B=0.2A$		0.3	0.5	V
Base to Emitter Saturation Voltage	$V_{BE(sat)}$	$I_C=2.0A$ $I_B=0.2A$		1.0	2.0	V
Transition Frequency	$f_T$	$V_{CE}=5.0V$ $I_C=0.1A$		90		MHz
Collector output capacitance	$C_{ob}$	$V_{CB}=10V$ $f=1.0MHz$ $I_E=0$		45		pF

电参数曲线图 / Electrical Characteristic Curve

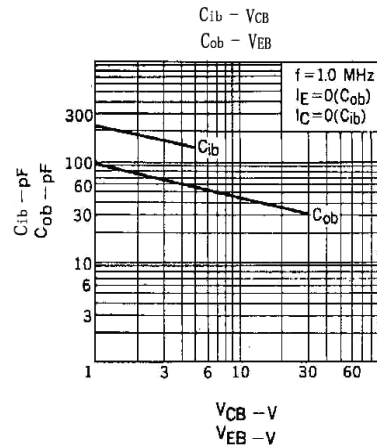
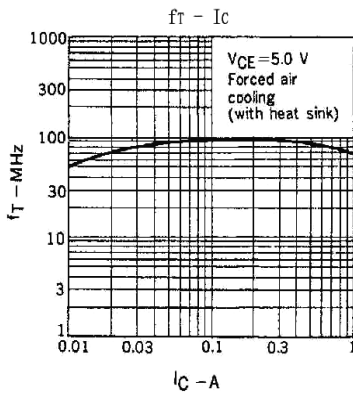
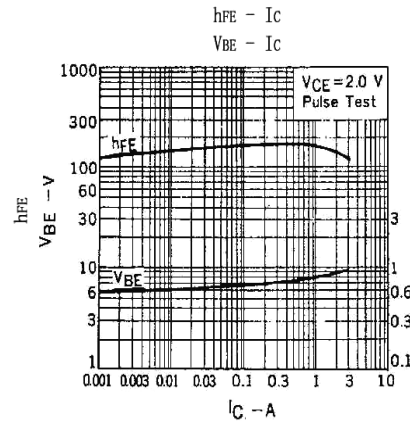
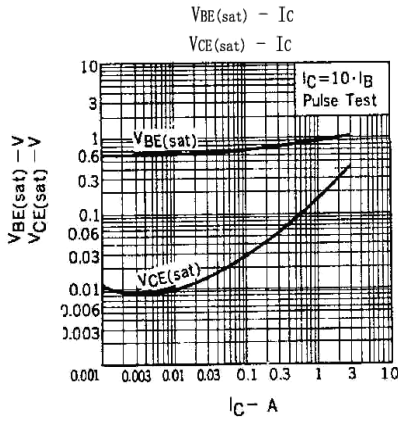
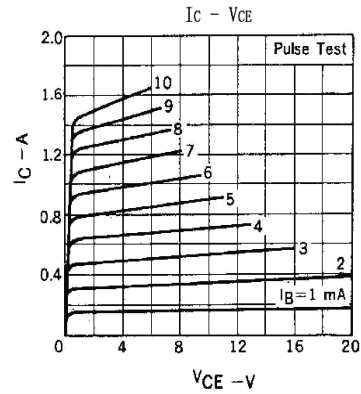
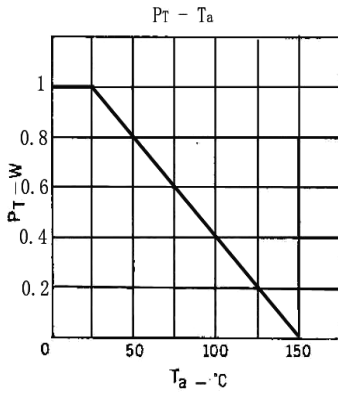

外形尺寸图 / Package Dimensions

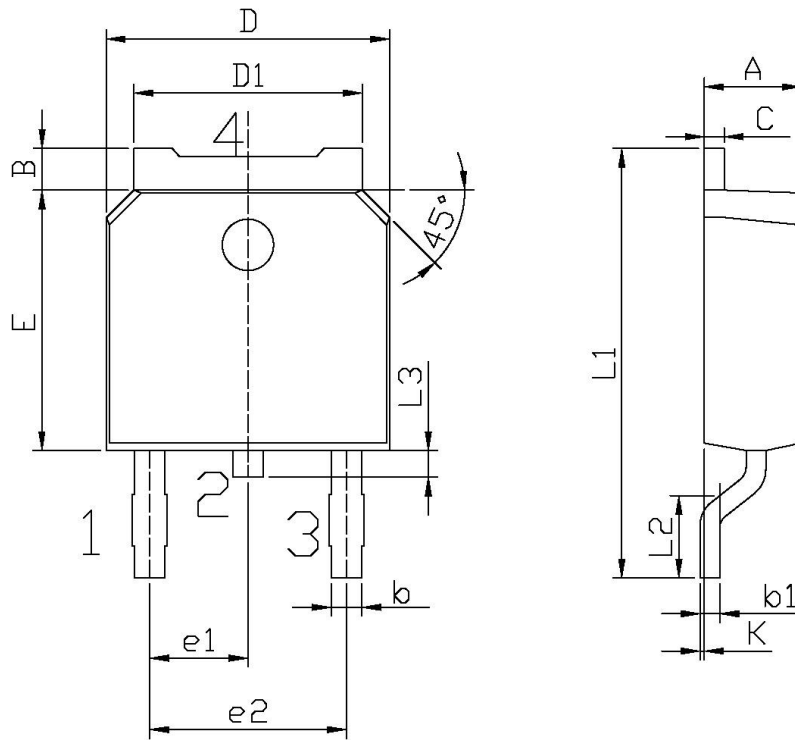

单位: mm

Symbol	Dimensions In Millimeters		Symbol	Dimensions In Millimeters	
	Min	Max		Min	Max
A	2.20	2.40	E	5.95	6.25
B	0.95	1.25	e1	2.24	2.34
b	0.70	0.90	e2	4.43	4.73
b1	0.45	0.55	L1	9.85	10.35
C	0.45	0.55	L2	1.70	2.00
D	6.45	6.75	L3	0.60	0.90
D1	5.10	5.50	K	0.00	0.10

TO-252

印章说明 / Marking Instructions

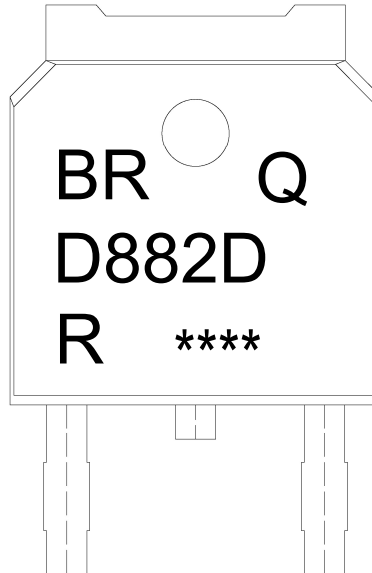

说明：

BR： 为公司代码

Q： 为汽车无卤产品标识

D882D： 为型号代码

R： 为  $h_{FE}$  分档代码

\*\*\*\*： 为生产批号代码，随生产批号变化

Note:

BR: Company Code

Q: Automobile halogen-free product Code

D882D: Product Type

R:  $h_{FE}$  Classifications Symbol

\*\*\*\*: Lot No. Code, code change with Lot No

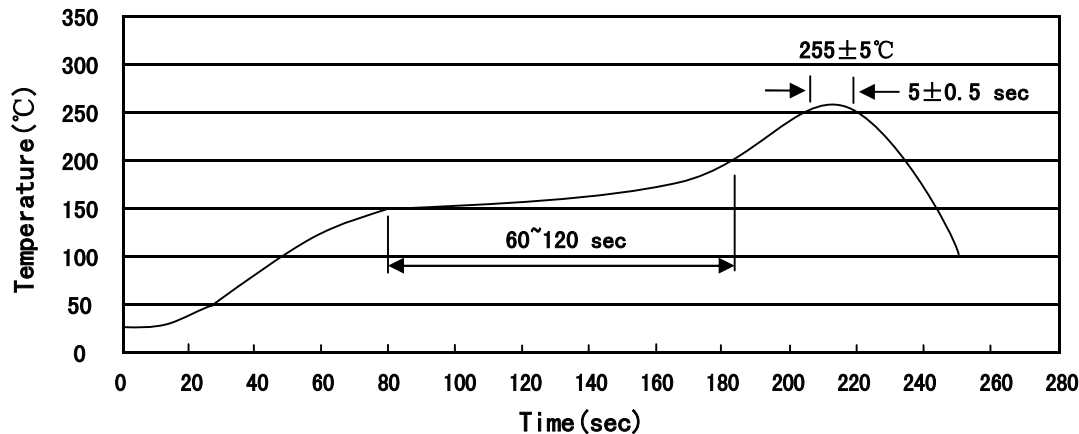
**回流焊温度曲线图(无铅) / Temperature Profile for IR Reflow Soldering(Pb-Free)**

说明：

- 1、预热温度 150~200°C，时间 60~120sec;
- 2、峰值温度 255±5°C，时间持续为 5±0.5sec;
- 3、焊接制程冷却速度为 2~10°C/sec.

Note:

- 1.Preheating:150~200°C, Time:60~120sec.
- 2.Peak Temp.:255±5°C, Duration:5±0.5sec.
3. Cooling Speed: 2~10°C/sec.

**耐焊接热试验条件 / Resistance to Soldering Heat Test Conditions**

温度：260±5°C

时间：10±1 sec.

Temp.:260±5°C

Time:10±1 sec

**包装规格 / Packaging SPEC.**

卷盘包装 / REEL

Package Type 封装形式	Units 包装数量					Dimension 包装尺寸 (unit: mm <sup>3</sup> )		
	Units/Reel 只/卷盘	Reels/Inner Box 卷盘/盒	Units/Inner Box 只/盒	Inner Boxes/Outer Box 盒/箱	Units/Outer Box 只/箱	Reel	Inner Box 盒	Outer Box 箱
TO-252	2,500	2	5,000	6	30,000	13" ×16	360×360×50	380×335×366

套管包装 / TUBE

Package Type 封装形式	Units 包装数量					Dimension 包装尺寸 (unit: mm <sup>3</sup> )		
	Units/Tube 只/套管	Tubes/Inner Box 套管/盒	Units/Inner Box 只/盒	Inner Boxes/Outer Box 盒/箱	Units/Outer Box 只/箱	Tube 套管	Inner Box 盒	Outer Box 箱
TO-251/252	75	48	3,600	5	18,000	526×20.5×5.25	555×164×50	575×290×180

**使用说明 / Notices**