

### 描述 / Descriptions

TO-252 塑封封装 N 沟道 MOS 场效应管。N-CHANNEL MOSFET in a TO-252 Plastic Package.

### 特征 / Features

低栅电荷,低反馈电容,开关速度快,无卤产品。  
Low gate charge, low crss, fast switching, HF Product.

### 用途 / Applications

用于高功率 DC/DC 转换和功率开关。  
These devices are well suited for high efficiency switching DC/DC converters and switch mode power supplies.

### 内部等效电路 / Equivalent Circuit

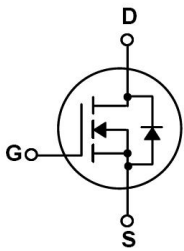

### 引脚排列 / Pinning

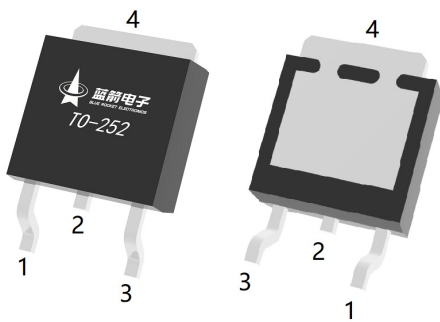

PIN 1 : G

PIN 2 : D

PIN 3 : S

PIN 4 : D

### 印章代码 / Marking

见印章说明。See Marking Instructions.

**极限参数 / Absolute Maximum Ratings(Ta=25°C)**

参数 Parameter	符号 Symbol	数值 Rating	单位 Unit
Drain-Source Voltage	V <sub>DSS</sub>	650	V
Drain Current	I <sub>D</sub> (Tc=25°C)	2.0	A
Drain Current	I <sub>D</sub> (Tc=100°C)	1.3	A
Drain Current - Pulsed	I <sub>DM</sub>	6.0	A
Gate-Source Voltage	V <sub>GSS</sub>	±30	V
Single Pulsed Avalanche Energy	E <sub>AS</sub>	120	mJ
Repetitive Avalanche Energy	E <sub>AR</sub>	5.4	mJ
Avalanche Current	I <sub>AR</sub>	2.0	A
Power Dissipation	P <sub>D</sub> (Tc=25°C)	37	W
Operating and Storage Temperature Range	T <sub>J</sub> , T <sub>STG</sub>	-55 to 150	°C

**电性能参数 / Electrical Characteristics(Ta=25°C)**

参数 Parameter	符号 Symbol	测试条件 Test Conditions	最小值 Min	典型值 Typ	最大值 Max	单位 Unit
Drain-Source Breakdown Voltage	BV <sub>DSS</sub>	V <sub>GS</sub> =0V I <sub>D</sub> =250μA	650			V
Zero Gate Voltage Drain Current	I <sub>DSS</sub>	V <sub>DS</sub> =650V V <sub>GS</sub> =0V			1.0	μA
		V <sub>DS</sub> =480V T <sub>C</sub> =125°C			100	μA
Gate-Body Leakage Current Forward	I <sub>GSS</sub>	V <sub>GS</sub> =±30V V <sub>DS</sub> =0V			±0.1	μA
Gate Threshold Voltage	V <sub>GS(th)</sub>	V <sub>DS</sub> =V <sub>GS</sub> I <sub>D</sub> =250μA	2.0		4.0	V
Static Drain-Source On-Resistance	R <sub>DS(on)</sub>	V <sub>GS</sub> =10V I <sub>D</sub> =1.0A		4.3	6.5	Ω
Forward Transconductance	g <sub>FS</sub>	V <sub>DS</sub> =40V I <sub>D</sub> =1.0A		2.05		S
Drain-Source Diode Forward Voltage	V <sub>SD</sub>	V <sub>GS</sub> =0V I <sub>S</sub> =2.0A			1.4	V
Input Capacitance	C <sub>iss</sub>	V <sub>DS</sub> =25V V <sub>GS</sub> =0V f=1.0MHz		320	420	pF
Output Capacitance	C <sub>oss</sub>			35	46	pF
Reverse Transfer Capacitance	C <sub>rss</sub>			4.5	6.0	pF
Turn-On Delay Time	t <sub>d(on)</sub>		V <sub>DD</sub> =300V I <sub>D</sub> =2.0A R <sub>G</sub> =25Ω		8.0	30
Turn-On Rise Time	t <sub>r</sub>			23	60	ns
Turn-Off Delay Time	t <sub>d(off)</sub>			25	60	ns
Turn-Off Fall Time	t <sub>f</sub>			28	70	ns

电参数曲线图 / Electrical Characteristic Curve

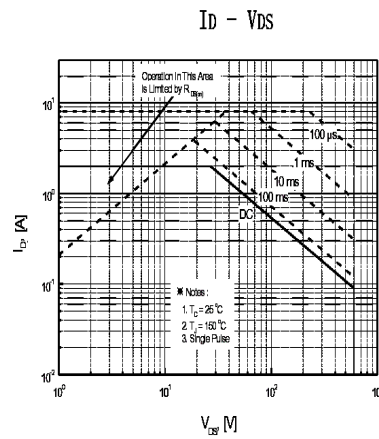
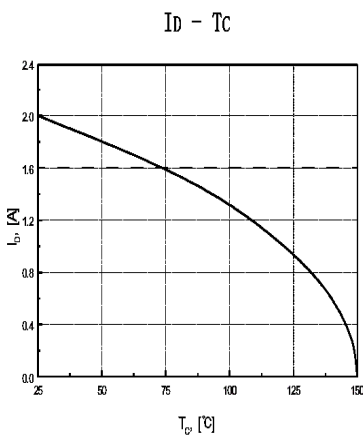
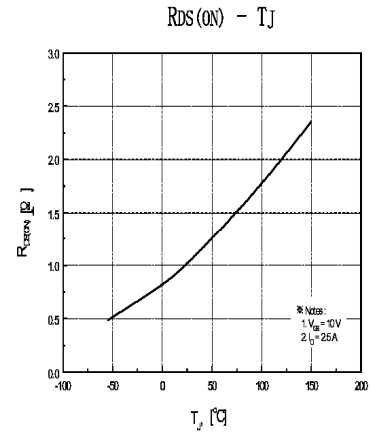
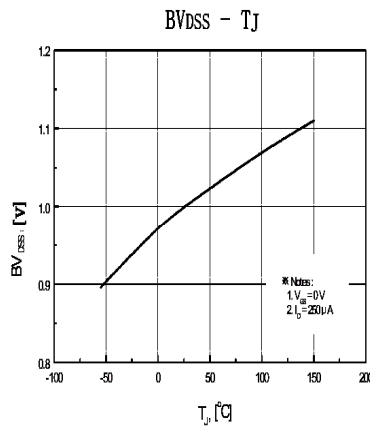
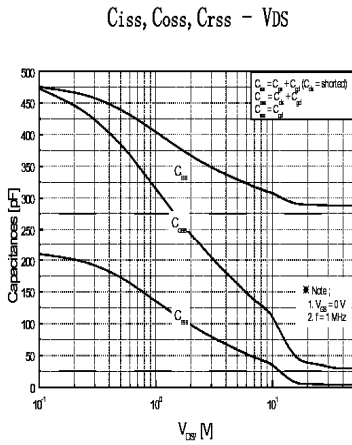
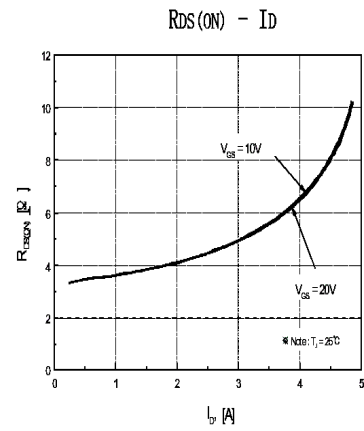
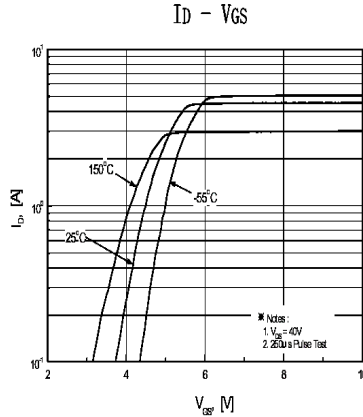
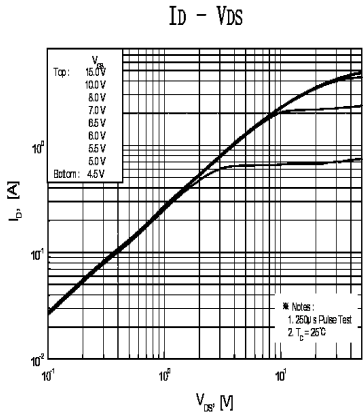

**外形尺寸图 / Package Dimensions**

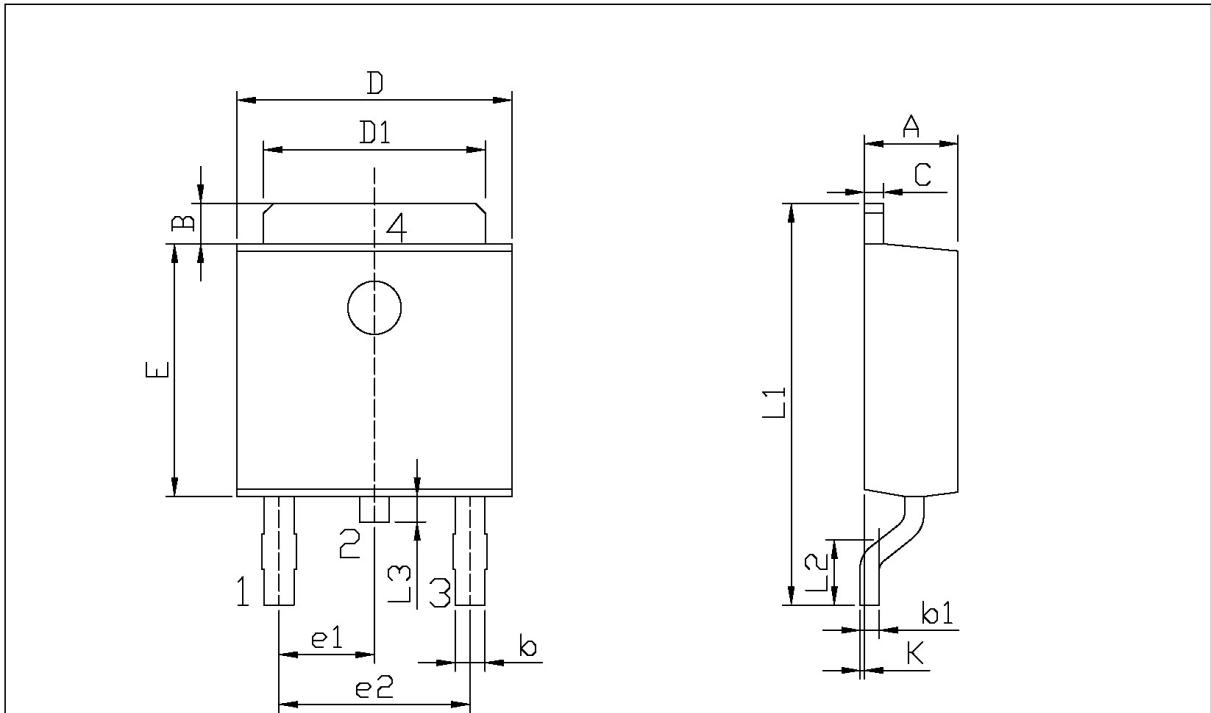

单位: mm

Symbol	Dimensions In Millimeters		Symbol	Dimensions In Millimeters	
	Min	Max		Min	Max
A	2.20	2.40	E	5.95	6.25
B	0.95	1.25	e1	2.24	2.34
b	0.50	0.90	e2	4.43	4.73
b1	0.45	0.55	L1	9.45	9.95
C	0.45	0.55	L2	1.25	1.75
D	6.45	6.75	L3	0.60	0.90
D1	5.10	5.50	K	0.00	0.10

TO-252

**印章说明 / Marking Instructions**

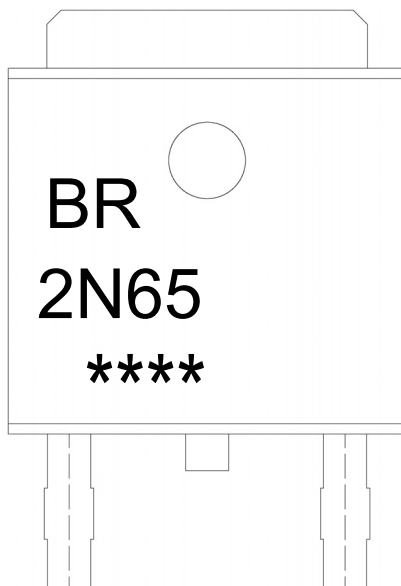

说明：

BR： 为公司代码

2N65： 为型号代码

\*\*\*\*： 为生产批号代码，随生产批号变化

Note:

BR: Company Code

2N65: Product Type

\*\*\*\*: Lot No. Code, code change with Lot No

**回流焊温度曲线图(无铅) / Temperature Profile for IR Reflow Soldering(Pb-Free)**

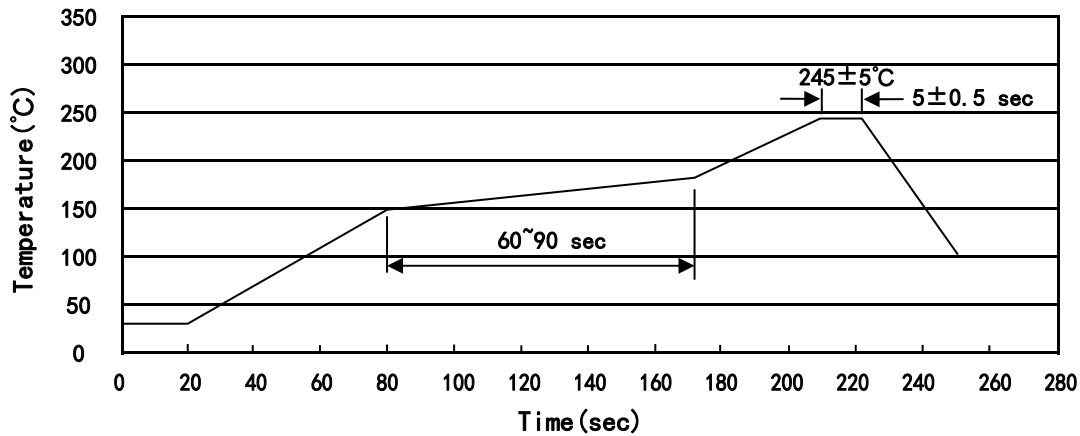

说明：

- 1、预热温度 150~180°C，时间 60~90sec;
- 2、峰值温度 245±5°C，时间持续为 5±0.5sec;
- 3、焊接制程冷却速度为 2~10°C/sec.

Note:

- 1.Preheating:150~180°C, Time:60~90sec.
- 2.Peak Temp.:245±5°C, Duration:5±0.5sec.
3. Cooling Speed: 2~10°C/sec.

**耐焊接热试验条件 / Resistance to Soldering Heat Test Conditions**

温度：260±5°C

时间：10±1 sec.

Temp.:260±5°C

Time:10±1 sec

**包装规格 / Packaging SPEC.**

卷盘包装 / REEL

Package Type 封装形式	Units 包装数量					Dimension 包装尺寸 (unit: mm <sup>3</sup> )		
	Units/Reel 只/卷盘	Reels/Inner Box 卷盘/盒	Units/Inner Box 只/盒	Inner Boxes/Outer Box 盒/箱	Units/Outer Box 只/箱	Reel	Inner Box 盒	Outer Box 箱
TO-252	2,500	2	5,000	6	30,000	13" ×16	360×360×50	380×335×366

套管包装 / TUBE

Package Type 封装形式	Units 包装数量					Dimension 包装尺寸 (unit: mm <sup>3</sup> )		
	Units/Tube 只/套管	Tubes/Inner Box 套管/盒	Units/Inner Box 只/盒	Inner Boxes/Outer Box 盒/箱	Units/Outer Box 只/箱	Tube 套管	Inner Box 盒	Outer Box 箱
TO-251/252	75	48	3,600	5	18,000	526×20.5×5.25	555×164×50	575×290×180

**使用说明 / Notices**